

DS系列 防水端子接綫盒

DS Series Terminal Block Box

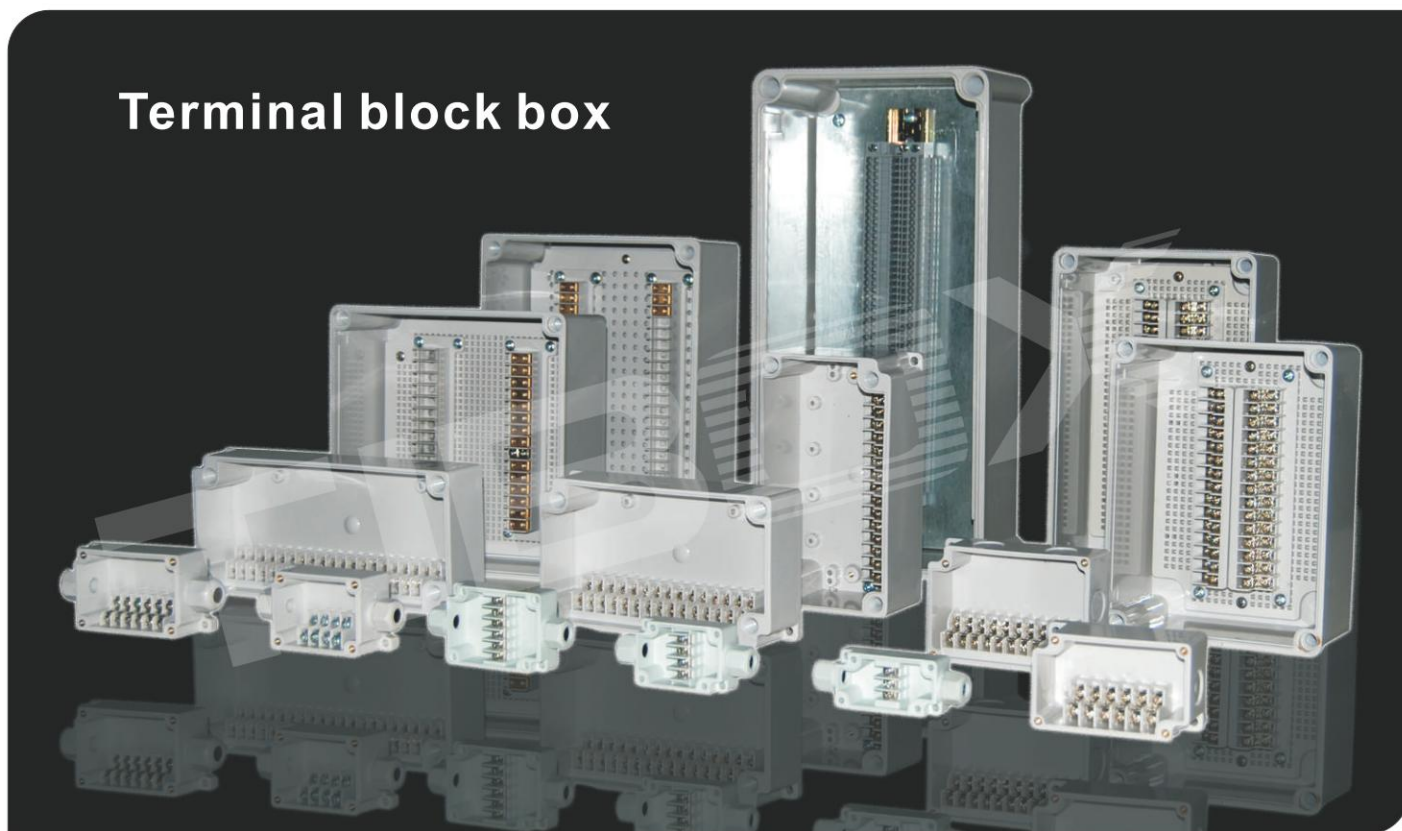

端子盒有極好的絕緣性能，抗化學腐蝕和抗機械擠壓的性能。達到高要求的IP66防護等級。所有的箱體都防塵、防水，能抗80度高温。產品採用高强度ABS、PC、PBT耐火材料和UV添加材料制成。外形美觀大方，具有很高的可塑性和堅固性。接綫端子排正常耐壓400V，耐高壓4KV，正常電流容量0.75mm sq.-1.5mm sq.端子規格有3P-60P多種規格滿足你的選擇。

The terminal block box, it is made by ABS material, Normal voltage: 400V The normal current capacity: 0.75mm sq.-15mm sq.
Temperature range: -40°C to +120°C ABS: Acrylonitrile Butadiene Styrene PC: Poly Carbamate
Product with hole can be used without separate processing

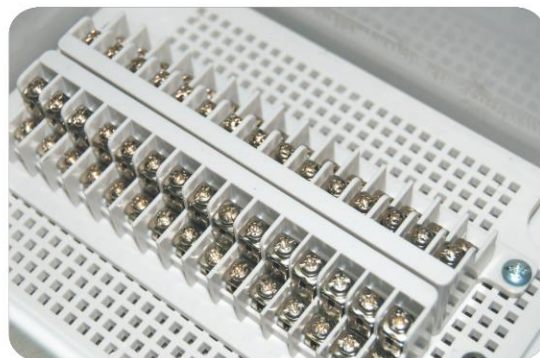
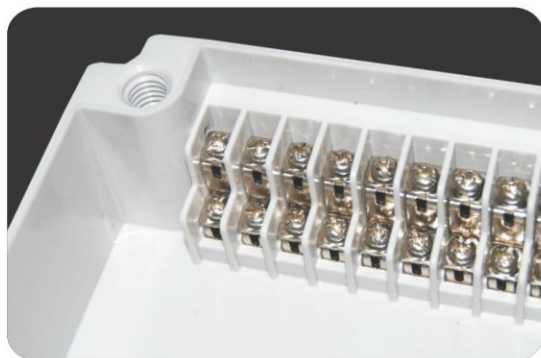

DS Series Terminal Block Box

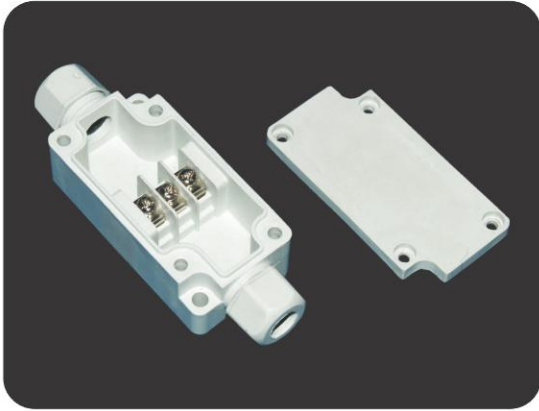

型號(Model): PBT-3P

尺寸(Size): 33 × 65 × 24mm

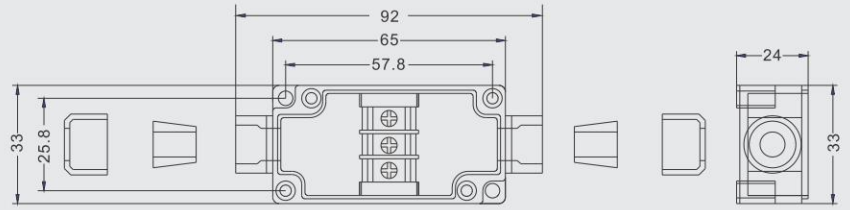

Dimension(允許誤差allowance ± 1mm)

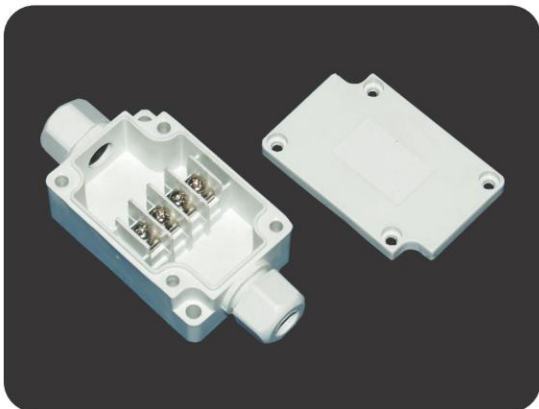

型號(Model): PBT-4P

尺寸(Size): 40 × 60 × 24mm

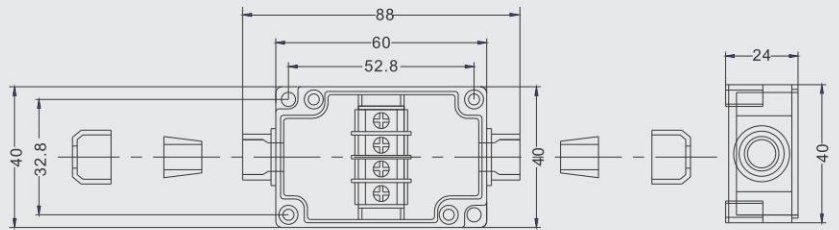

Dimension(允許誤差allowance ± 1mm)

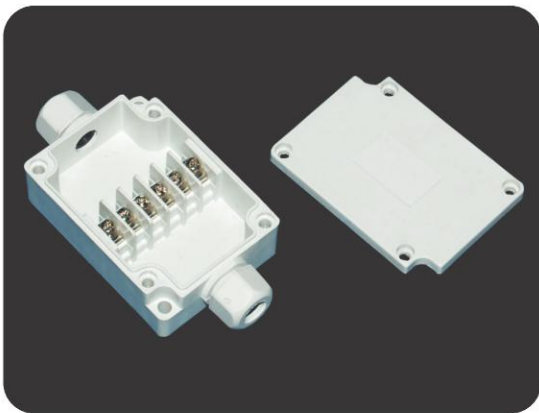

型號(Model): PBT-6P

尺寸(Size): 50 × 70 × 24mm

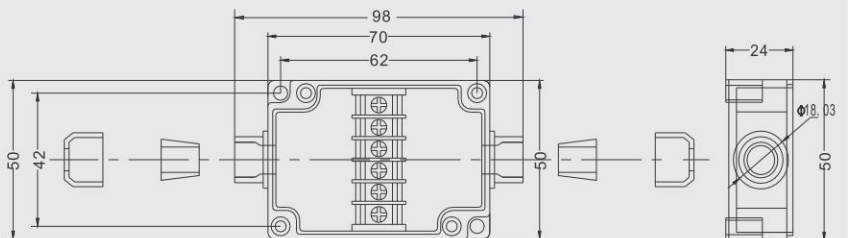

Dimension(允許誤差allowance ± 1mm)



型號(Model): DS-MTB-4P

尺寸(Size): 50 × 102 × 40mm

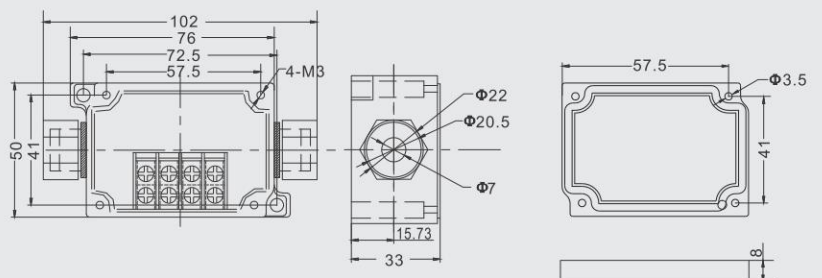

Dimension(允許誤差allowance ± 1mm)

DS系列 防水端子接綫盒

DS Series Terminal Block Box

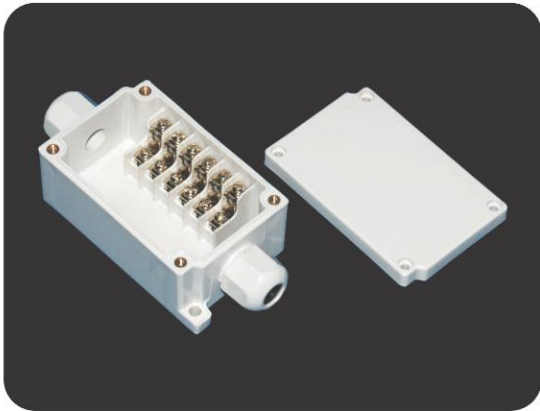

型號(Model): DS-MTB-6P

尺寸(Size): 55 × 125 × 40mm

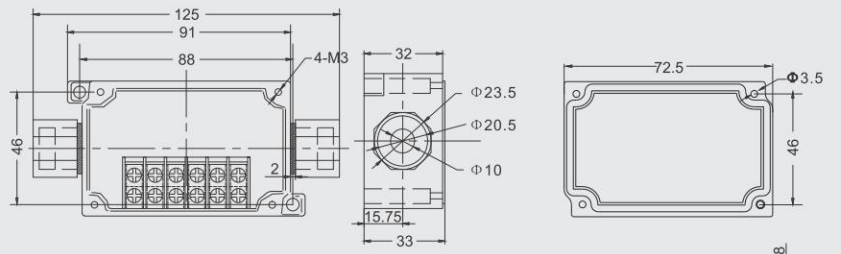

Dimension(允許誤差allowance ± 1mm)



型號(Model): DS-4P-K

尺寸(Size): 55 × 70 × 43mm

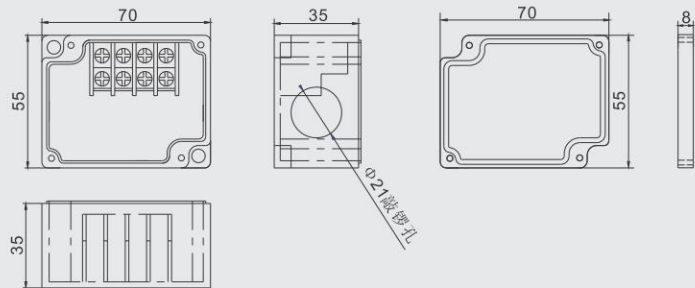

Dimension(允許誤差allowance ± 1mm)



型號(Model): DS-6P-K

尺寸(Size): 55 × 91 × 43mm

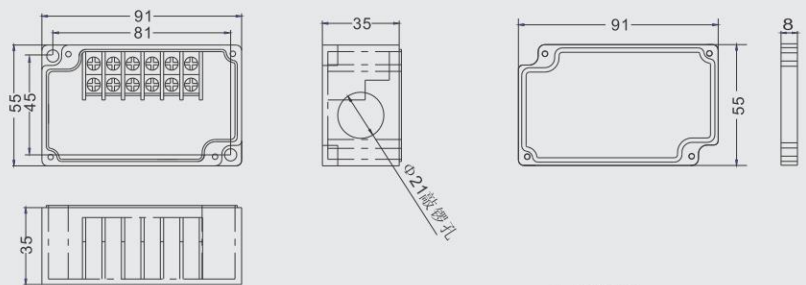

Dimension(允許誤差allowance ± 1mm)

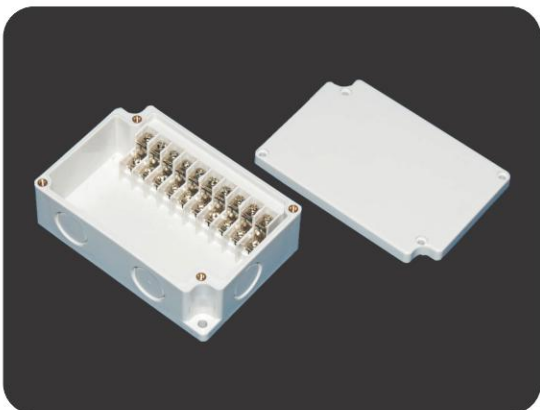

型號(Model): DS-PG-10P

尺寸(Size): 75 × 110 × 40mm

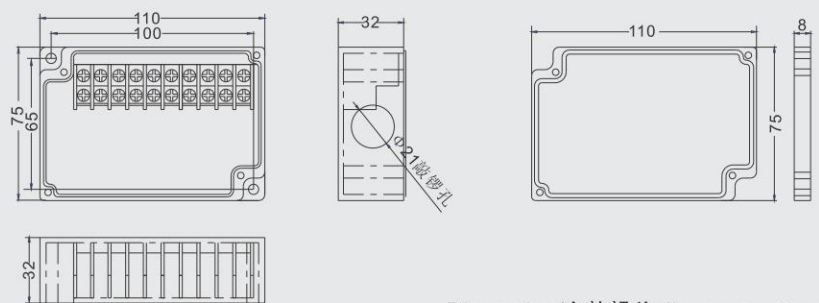

Dimension(允許誤差allowance ± 1mm)

DS Series Terminal Block Box



型號(Model): DS-PG-15P

尺寸(Size): 100 × 180 × 55mm

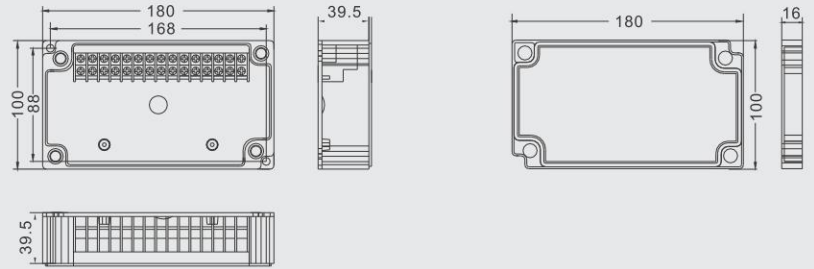

Dimension(允許誤差allowance ± 1mm)



型號(Model): DS-PG-15P-S

尺寸(Size): 100 × 180 × 75mm

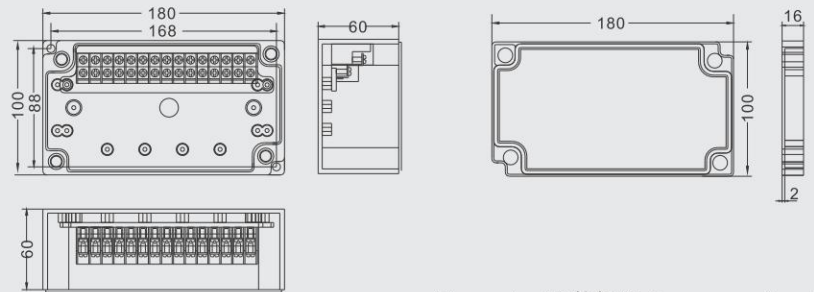

Dimension(允許誤差allowance ± 1mm)



型號(Model): DS-PG-20P-S

尺寸(Size): 100 × 223 × 75

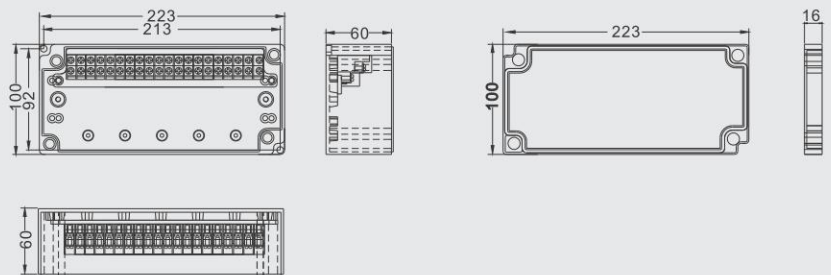

Dimension(允許誤差allowance ± 1mm)



型號(Model): DS-4P-M

尺寸(Size): 55 × 91 × 43mm

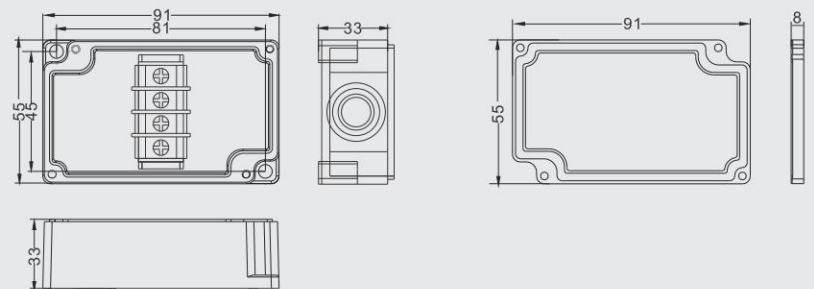

Dimension(允許誤差allowance ± 1mm)

DS系列 防水端子接綫盒

DS Series Terminal Block Box



型號(Model): DS-6P-M

尺寸(Size): 75 × 91 × 43mm

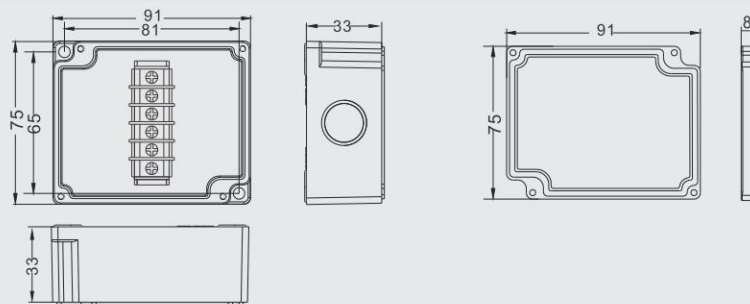

Dimension(允許誤差allowance ± 1mm)



型號(Model): DS-PG-10P-M

尺寸(Size): 91 × 110 × 43mm

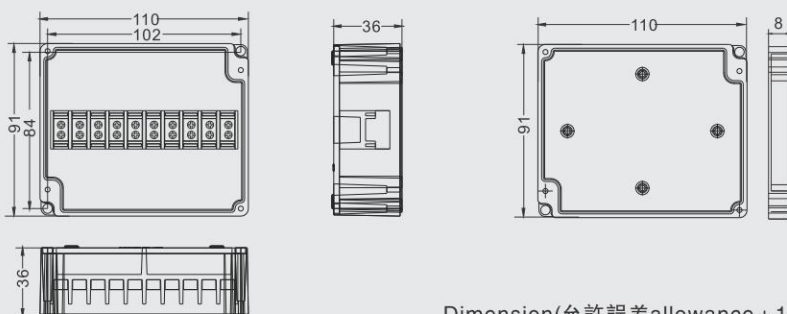

Dimension(允許誤差allowance ± 1mm)

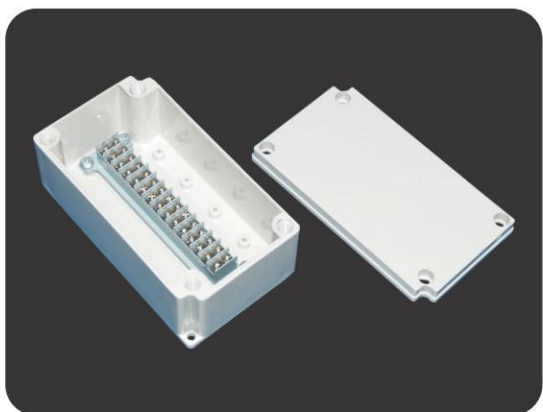

型號(Model): DS-PG-15P-M

尺寸(Size): 100 × 180 × 75mm

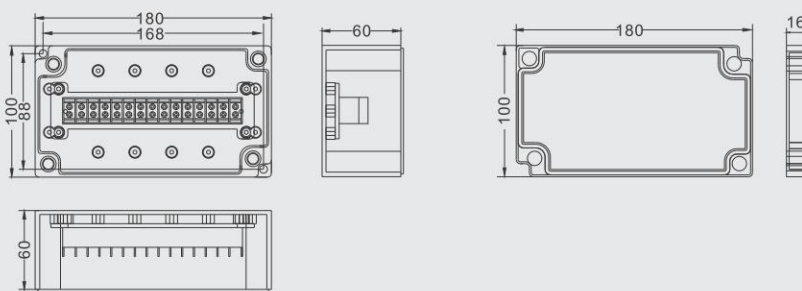

Dimension(允許誤差allowance ± 1mm)

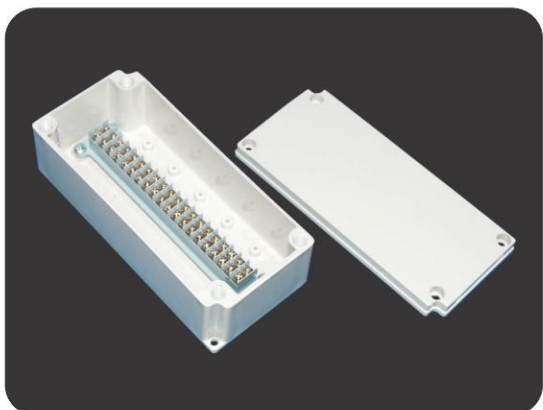

型號(Model): DS-PG-20P-M

尺寸(Size): 100 × 223 × 75mm

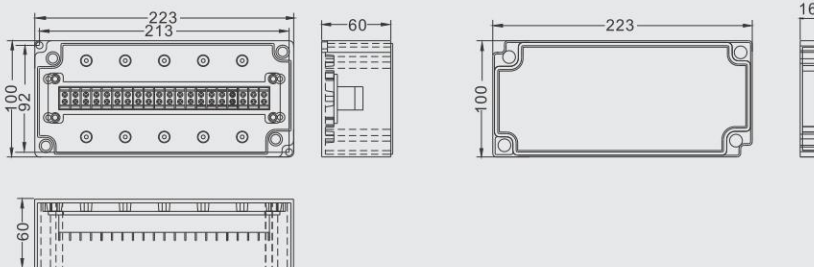

Dimension(允許誤差allowance ± 1mm)

DS Series Terminal Block Box

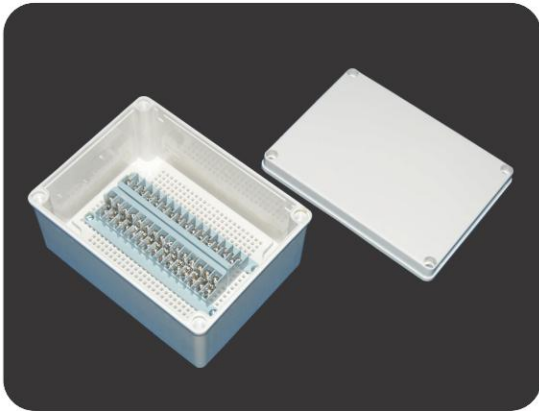

型號(Model): DS-AG-30P-S 尺寸(Size): 150×200×100mm

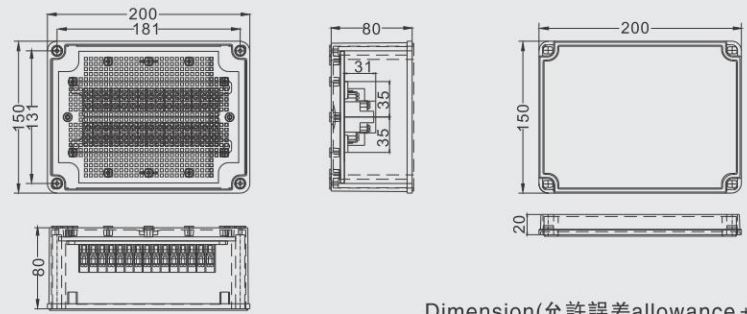

Dimension(允許誤差allowance ± 1mm)

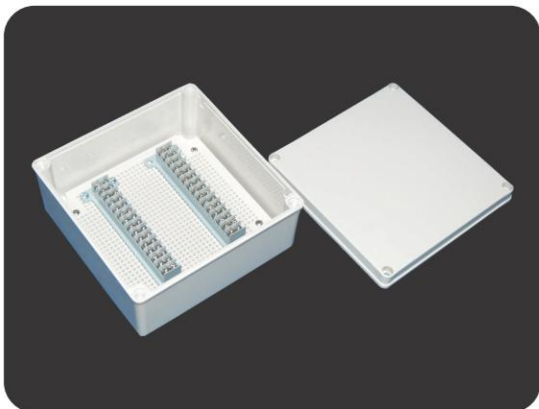

型號(Model): DS-AG-30P-M 尺寸(Size): 200×200×95mm

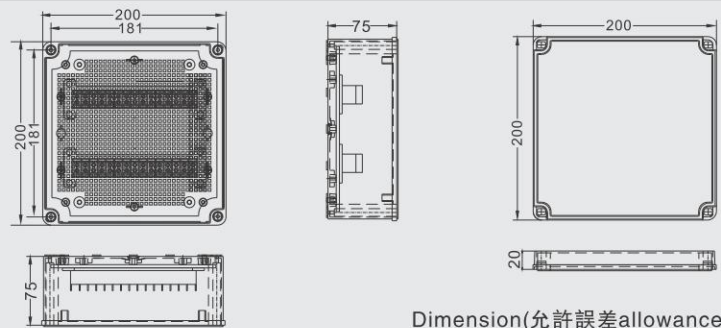

Dimension(允許誤差allowance ± 1mm)

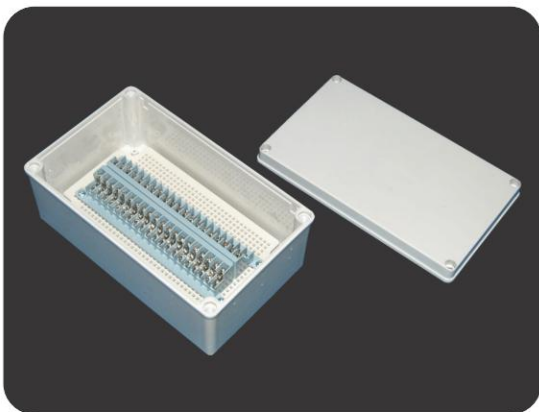

型號(Model): DS-AG-40P-S 尺寸(Size): 150×250×100mm

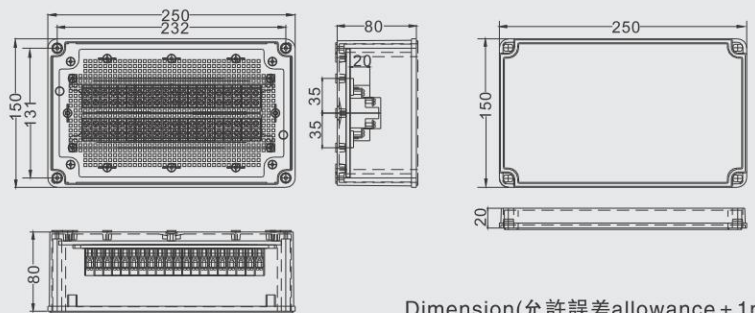

Dimension(允許誤差allowance ± 1mm)

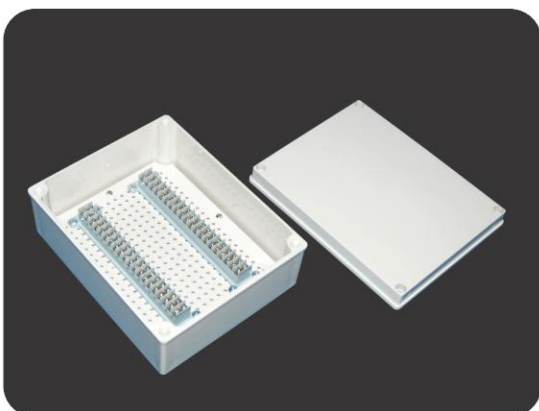

型號(Model): DS-AG-40P-M 尺寸(Size): 200×250×100mm

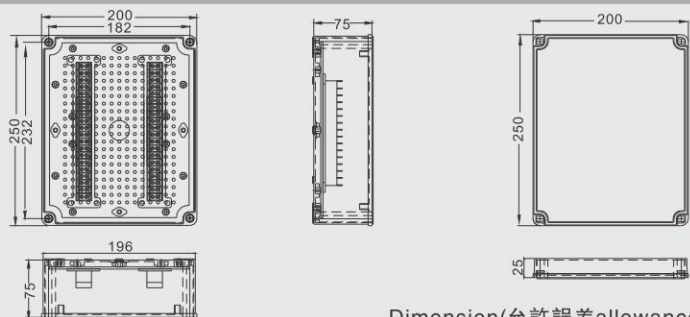

Dimension(允許誤差allowance ± 1mm)

DS系列 防水端子接綫盒

DS Series Terminal Block Box

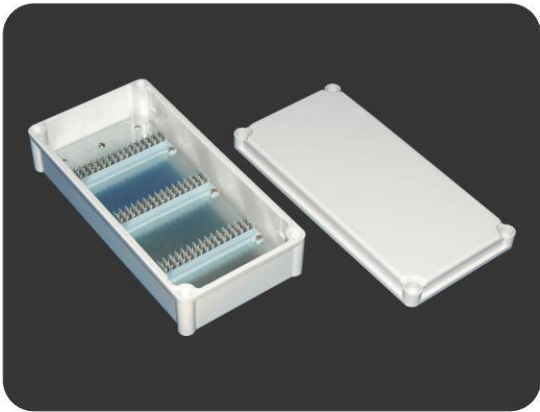

型號(Model): DS-AG-45P

尺寸(Size): 380 × 190 × 100mm

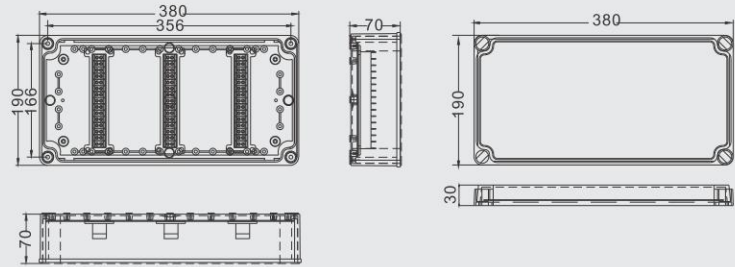

Dimension(允許誤差allowance ± 1mm)

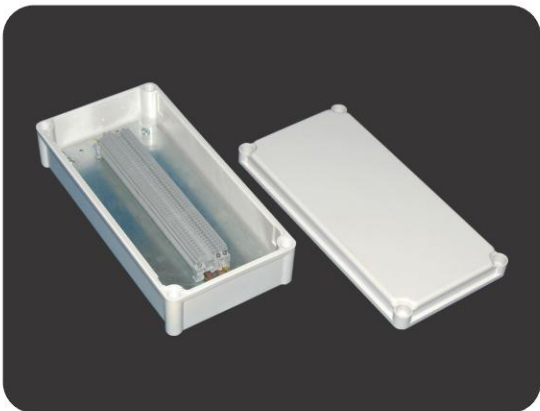

型號(Model): DS-AG-50P

尺寸(Size): 380 × 190 × 100mm

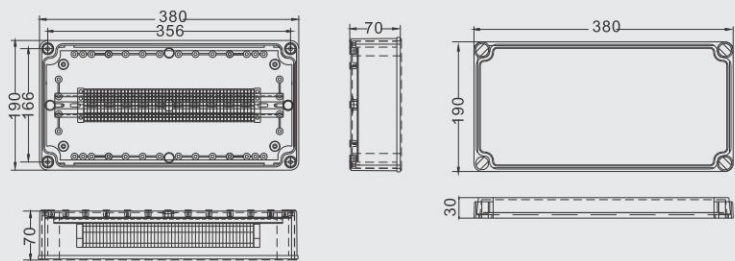

Dimension(允許誤差allowance ± 1mm)

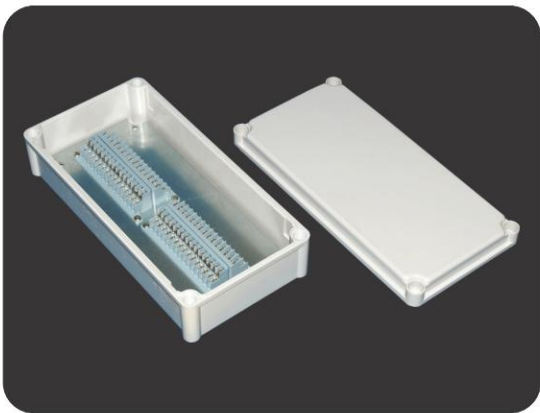

型號(Model): DS-AG-60P

尺寸(Size): 380 × 190 × 100mm

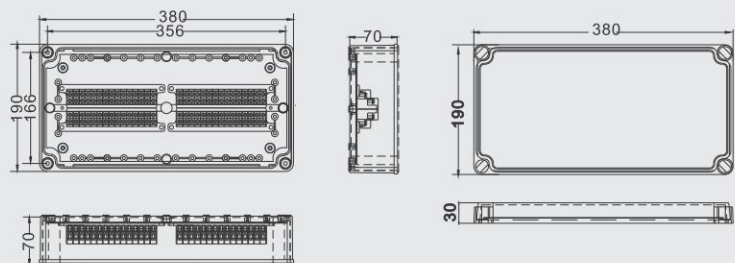

Dimension(允許誤差allowance ± 1mm)



TB-15P-M

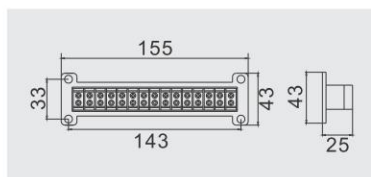

TB-15P-S

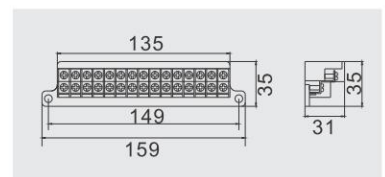

TB-20P-M

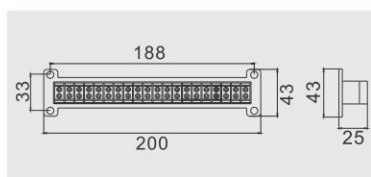

TB-20P-S

